

**Tunnel Mill
Polymer, Inc.**

Action	By	Date
Drawn	BD	12/7/04
Checked	SD	
Revised	DO	
Revised		
Revised		
Drawing Number		Revision
PRELIM		A

ADC ACE132S
Mounted on
B365406-12
/ U304836
Elevations -
Planview

A digital version of this drawing can be downloaded on
the web @ www.tunnelmill.com

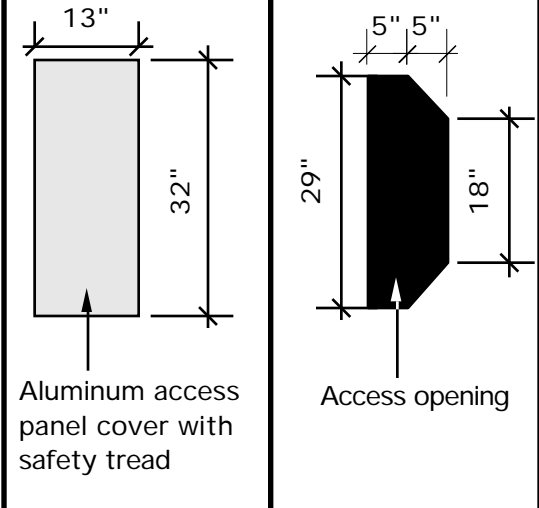
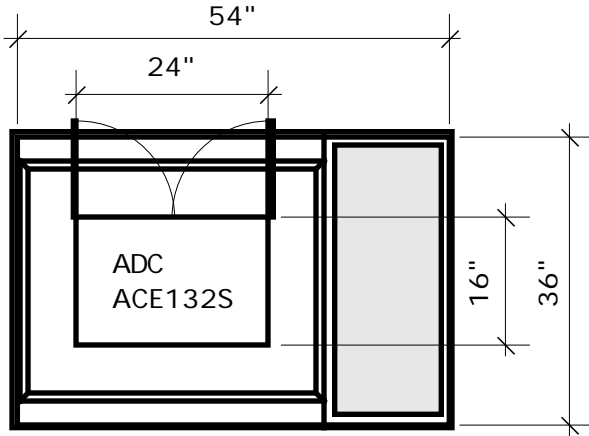

The aluminum access panel, with safety tread plate, covers an opening as shown.

